

## Description

■ This device is an ultra low capacitance ESD product designed to protect very high speed data interfaces. ESDPSA0402V30 has a typical capacitance of only 0.05pf (I/O to GND), and it can be used to meet the ESD immunity requirements of IEC61000-4-2 (15KV air, 8KV contact discharge).

## Feature

- ESD protection for high speed data lines to IEC61000-4-2
- ESD contact discharge typical 8KV, max 15KV
- ESD air discharge typical 15KV, max 25KV
- Surface mount
- Extremely low capacitance
- Very low leakage current
- Fast response time
- Bi-directional ESD protection
- Lead free solder termination
- The best ESD protection for high frequency, low voltage applications

## Application

- High Definition Multi-Media Interface (HDMI)
- Digital Visual Interface (DVI)
- Display Port Interface (DP)
- Unified Display Interface (UDI)
- Mobile Display Digital Interface (MDDI)
- Gigabit Ethernet
- USB2.0 and USB3.0
- IEEE1394 interface

## ESDPSA0402V30

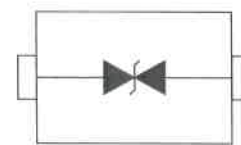

Schematic Diagram

### Caution:

**This component is designed for signal line protection only,  
Not intended to be used under bias, not for application with a power line.**

## Absolute Maximum Ratings

Parameter	Symbol	Value	Unit
Maximum Contact discharge voltage Per IEC61000-4-2	---	15KV	V
Maximum Air discharge voltage Per IEC61000-4-2	---	25KV	V
Maximum Operating temperature	T <sub>OPER</sub>	-55 to +125	°C
Maximum Storage temperature	T <sub>STG</sub>	-55 to +125	°C
Maximum lead temperature for soldering during 10s	T <sub>L</sub>	260	°C

## Electrical Characteristics(T<sub>A</sub>=25°C)

Parameter	Symbol	Test Conditions	Min	Typ	Max	Units
Rated Voltage	V <sub>R</sub>	---	---	---	30	V
Trigger voltage	V <sub>T</sub>	IEC61000-4-2 8KV contact discharge	---	300	---	V
Clamping voltage	V <sub>C</sub>	IEC61000-4-2 8KV contact discharge	---	35	---	V
Leakage current	I <sub>L</sub>	DC 30V shall be applied on component	---	0.01	0.10	uA
Capacitance	C <sub>P</sub>	V <sub>R</sub> = 0V, f = 1MHz	---	0.05		pF

Note: 1 Trigger and clamping voltage are measured per IEC 61000-4-2, 8KV contact discharge method.

2 After reliability tests such as high temp storage, temp cycles, continuous ESD strike etc, the maximum leakage current is less than 10uA.

## ESD Clamping Test

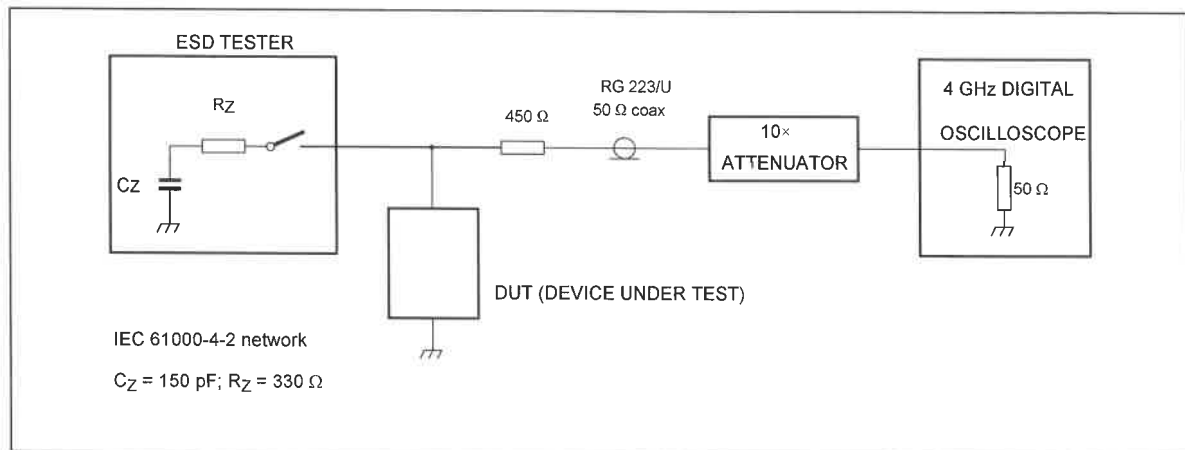

## ESD Clamping Test Waveforms

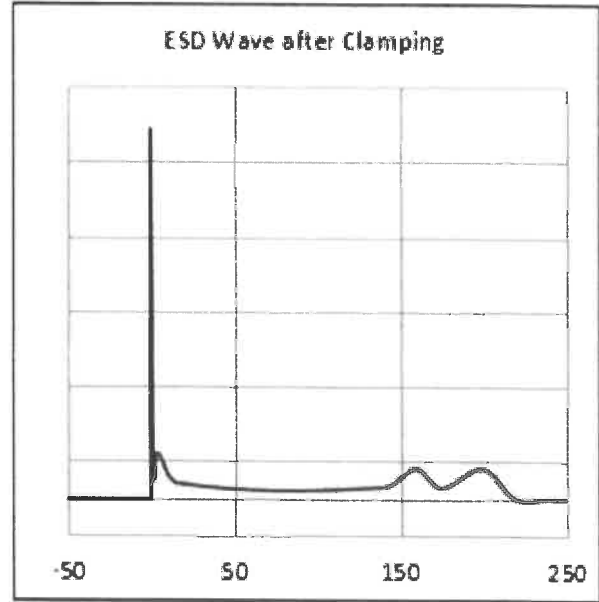
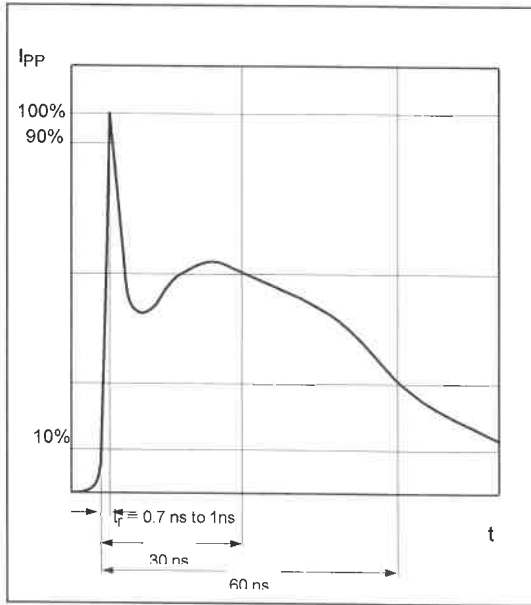

## Product Dimension

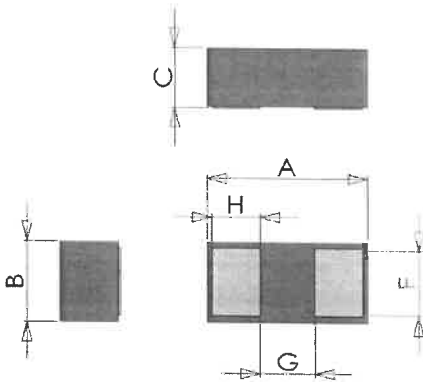

Symbol	Dimension			Unit
	Min	Typ	Max	
A	0.95	1.0	1.05	mm
B	0.45	0.50	0.55	
C	0.32	0.36	0.40	
H	0.28	0.30	0.32	
F	0.41	0.43	0.45	
G	0.32	0.34	0.36	

## PAD Dimension

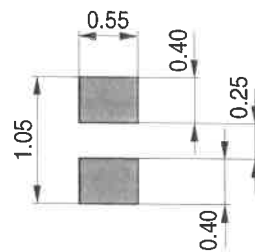

Dimensions in mm

Solder thickness 0.08 to 0.12mm recommended

## Solder Reflow Recommendations

Temperatures (°C)

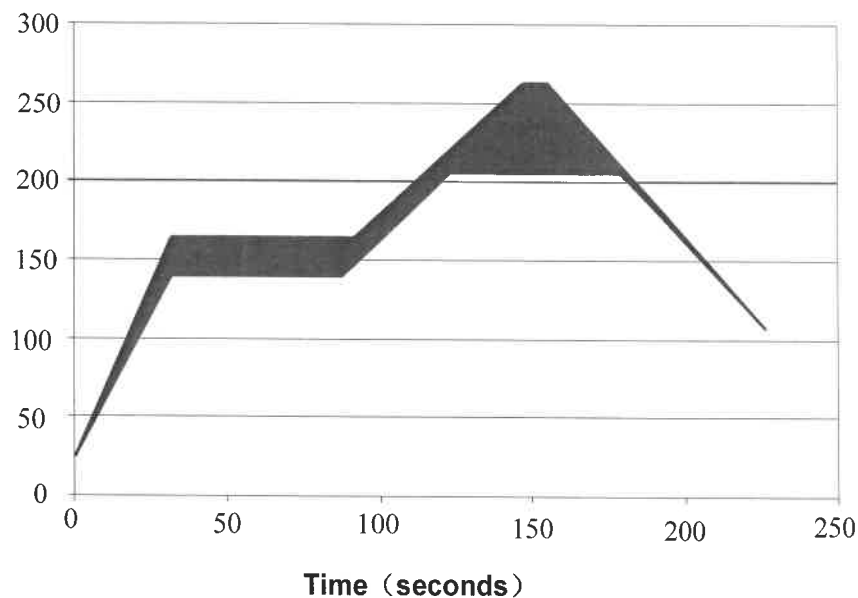

## Package Information

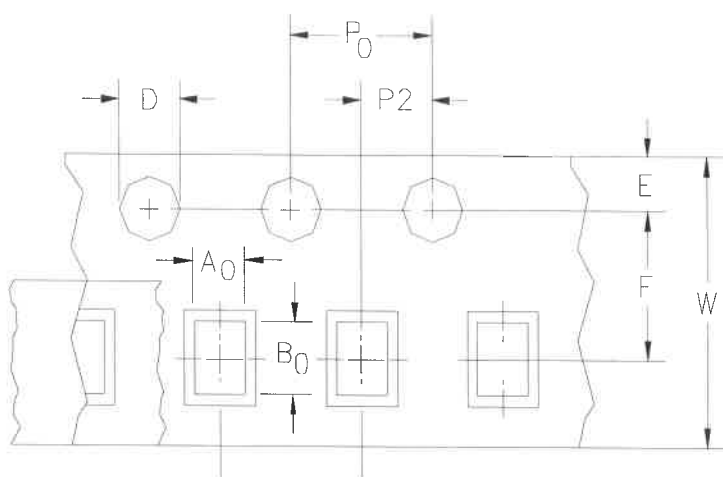

Dimension	Typical	Unit
A0	0.68	mm
B0	1.17	
D	1.55	
P0	4.00	
P1	2.00	
P2	2.00	
E	1.75	
F	3.50	
W	8.00	

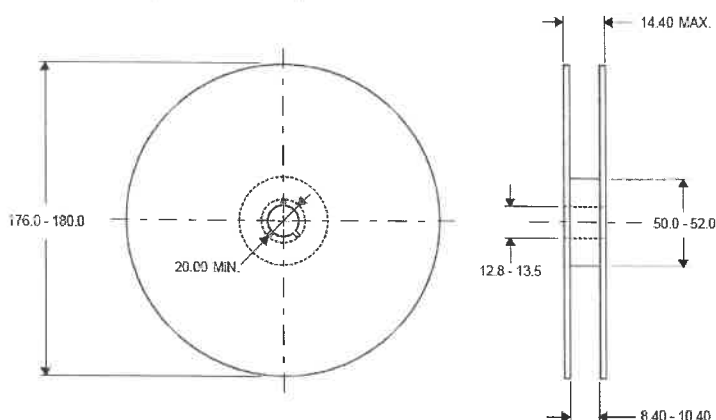

DIMENSIONS ARE: MILLIMETERS

## Part Number System

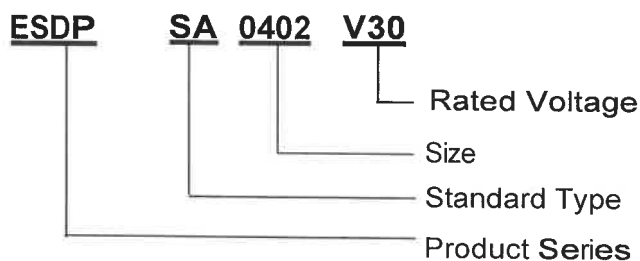

## Order Information

Device	Package	Net Weight	Carrier	Quantity	HSF Status
ESDPSA0402V30	0402	0.44 mg	Tape & Reel	10,000pcs/reel	RoHS compliant

## Revision history

Date	Revision	Description of changes
17-July-2020	5.0	Update

### CAUTION / WARNING

- Information in this document is believed to be accurate and reliable. However, SEMITEL does not give any representations or warranties, expressed or implied, as to the accuracy or completeness of such information and shall have no liability for the consequences of use of such information.
- Users should independently evaluate the suitability of and test each product selected for their own applications, and SEMITEL assumes no liability whatsoever relating to the choice, selection or use of the SEMITEL products and services described herein.
- SEMITEL reserves the right to change or update, without notice, any information contained in this publication; to change, without notice, the design, construction, processing, or specification of any product; and to discontinue or limit production or distribution of any product.
- Information in this document supersedes and replaces all information previously supplied.
- Products are not designed, authorized or warranted to be suitable for use in medical, military, aircraft, space or life support equipment, nor in applications where failure or malfunction of an SEMITEL product can reasonably be expected to result in personal injury, death or severe property or environmental damage. SEMITEL accepts no liability for inclusion and/or use of SEMITEL products in such equipment or applications and therefore such inclusion and/or use are at the customer's own risk.
- This document as well as the item(s) described herein may be subject to export control regulations. Export might require a prior authorization from national authorities.
- Resale of SEMITEL products with provisions different from the statements and/or technical features set forth in this document shall immediately void any warranty granted by SEMITEL for the SEMITEL product or service described herein and shall not create or extend in any manner whatsoever, any liability of SEMITEL.
- SEMITEL expressly disclaims all implied warranties regarding the information contained herein, including, but not limited to, any implied warranties of merchantability or fitness for a particular purpose. SEMITEL only obligations are those in the SEMITEL Standard Terms and Conditions of Sale and in no case will SEMITEL be liable for any incidental, indirect, or consequential damages arising from the sale, resale, use, or misuse of its products.

Specifications are subject to change without notice

© Copyright 2005, Semitel Electronics

 . ® is a registered trademark of Semitel Electronics

All rights reserved